

Technical Specifications

Electrical Specifications				
Parameter	Min.	Typ.	Max.	Units
Frequency	2000		2700	MHz
Output Power (P3dB)	40			dBm
Gain For Small Signal		47		dB
Gain Flatness Over Frequency		±0.75	±1	dB
Efficiency @ 40 dBm P _{out}	40%	45%		
Noise Figure 2)		1.5	2	dB
Input Return Loss (S11)	13	16		dB
IMD3 Rejection @ 40 dBm PEP 3)		30		dBc
2nd Harmonic Rejection @ 40 dBm P _{out}	45	50		dBc
3rd Harmonic Rejection @ 40 dBm P _{out}	50	55		dBc
DC Supply Voltage		28		V
Supply Current @ 40 dBm P _{out}		0.8	0.9	A
Operating Temperature	-20		80	°C

Maximum Ratings 1)	
Parameter	Ratings
DC Voltage	35 V
RF Input Power	30 dBm
Load VSWR	1 : ∞

1) Permanent damage may occur if any of these limits are exceeded.

2) Noise figure specified at 18 °C, will increase with higher temperature.

3) Twotone test: Δf = 1 MHz



Mechanical Specifications	
Input Connector	SMA-female, 50 ohms
Output Connector	SMA-female, 50 ohms
DC I/O Interface	D-Sub, male, 9 pin
Case	milled aluminium case with protective surface finish
Dimensions (L x W x H)	85 x 85 x 40 mm
Weight	495 g

Applications:

Communication systems
Measurement and laboratory equipment

Fulfilled Standards:

EMC directive 2014/30/EU
Low voltage directive 2014/35/EU
RoHS directive 2011/65/EU

Features:

Flat gain
Reverse power protection
High efficiency

Pin Description

Pin Number	Function
Pin 1, Pin 6	V+/Supply voltage
Pin 2, Pin 7	V-/GND
Pin 3	Enable in
Pin 4	Temperature monitor out
Pin 5	Forward power monitor out
Pin 8	Error flag out
Pin 9	Reverse power monitor out

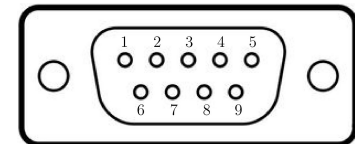

DC I/O Interface
D-Sub, male, 9 pin

Temperature monitor out: temperature: -20...+100 °C mapped to 0...2.5V output voltage. For a coarse evaluation, a linear temperature-voltage-characteristic can be assumed (max. error ± 3.5 °C in the 0...80 °C range). For an exact measurement of temperature, the characteristic should be calibrated by the user.

Forward/Reverse power monitor out: logarithmic detector, 40 dB dynamic range, 0...2.5V output voltage.

Error flag out: high: normal operation, low: Overtemperature shutdown or supply fault.

Enable in: accepts input voltages from +3V to +50V, current consumption in off state < 500 μA, (connect to DC supply if not needed).

Notice

All Pins are protected against ESD and short circuit.
 Over temperature shutdown: active above 80 °C, automatic reset below 65 °C.
 The amplifier shall be mounted to a heat sink or solid metal plate for conduction cooling.
 ISO14580 M3 screws are recommended for mounting.
 Additional protection against moisture is essential in case of outdoor installation. Installation in a waterproof case is recommended.

Typical RF Performance

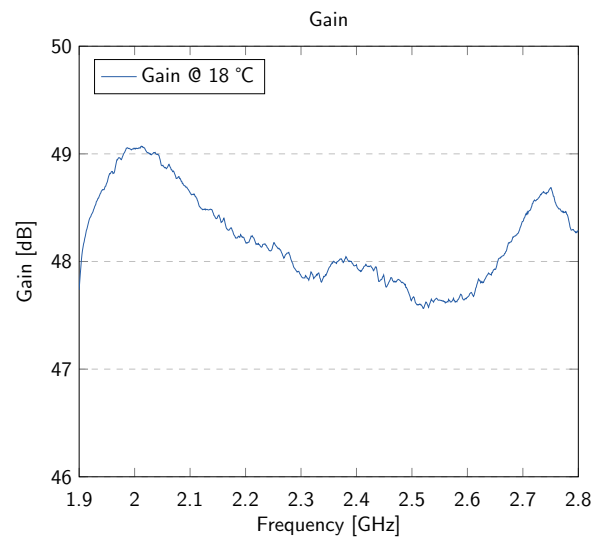
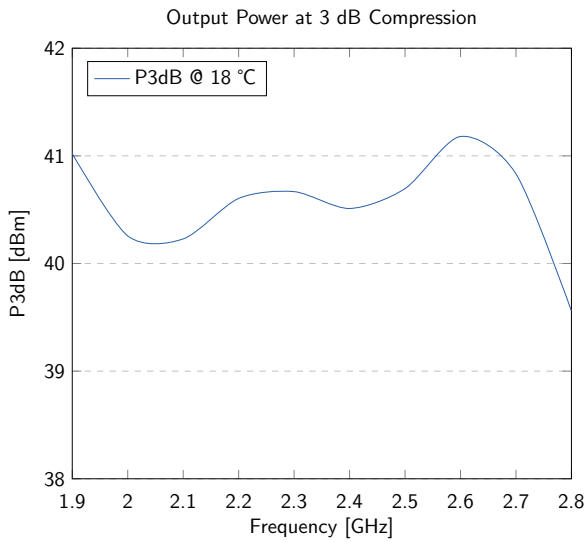

Test Certificate

Sig.: _____

QS: _____

SN: _____

Typical Measurement Data

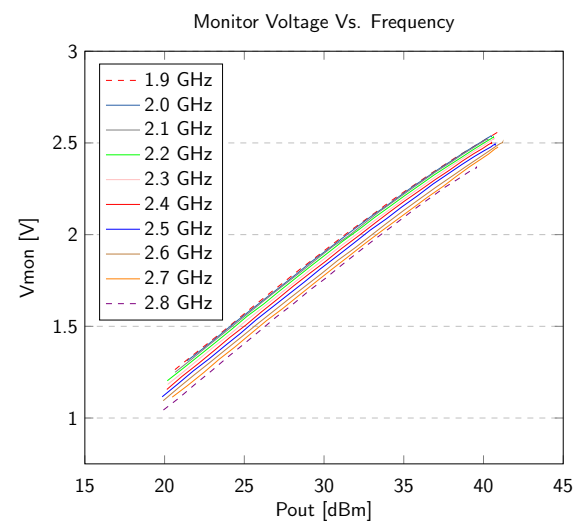
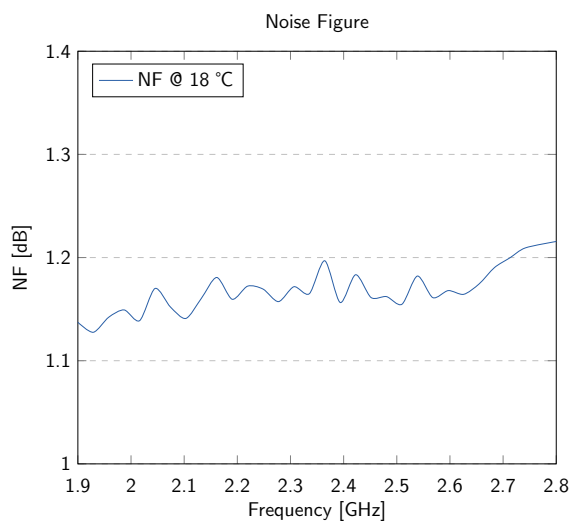
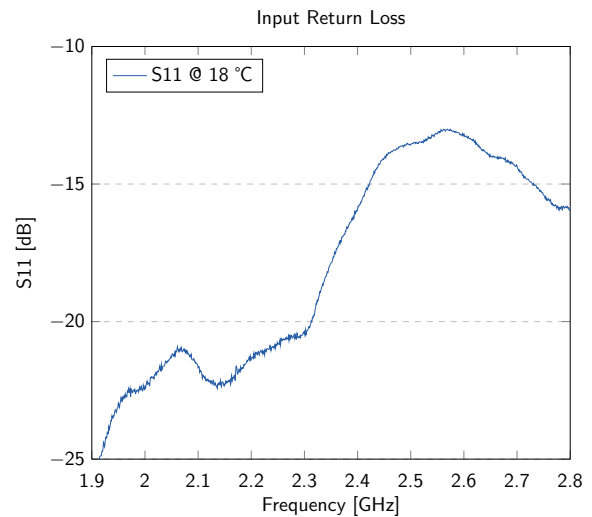
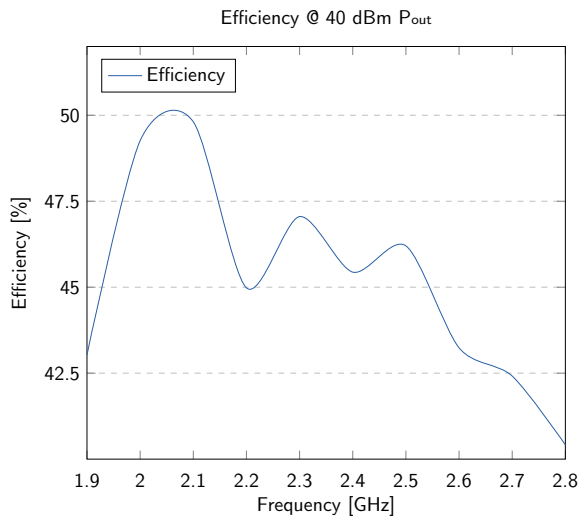



Typical Measurement Data

Frequency (MHz)	Input Return Loss	P3dB (dBm)	Gain (dB)	Noise Figure (dB)
1900	25.88	41,0	47.7	1,14
2000	22.37	40.3	48.9	1.14
2100	21.68	40.2	48.9	1.14
2200	21.35	40.6	48.5	1.16
2300	20.36	40.7	48.0	1.17
2400	15.91	40.5	47.9	1.16
2500	13.55	40.7	48.5	1.15
2600	13.18	41.2	48.6	1.17
2700	14.35	40.8	48.4	1.19
2800	15.90	39.6	48.3	1.22

Outline Drawings

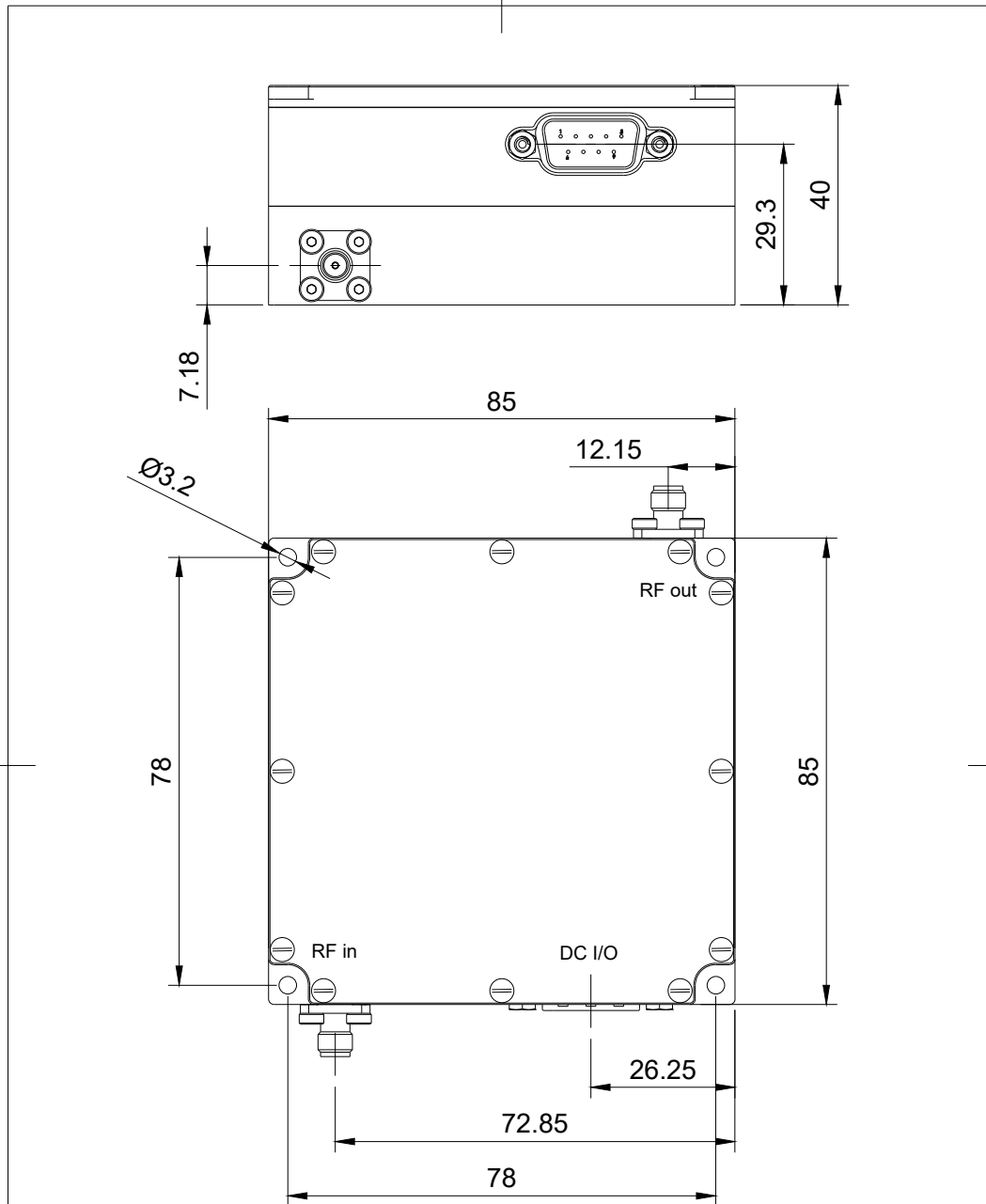
(Unit: mm)



Dept. R&D	Technical reference	Created by CM	29.05.2019	Approved by CM	29.05.2019
		Document type Outline drawing	Document status		
		Title KUPA200270-10A	DWG No.		
		Rev. 1	Date of issue 29.05.2019	Sheet 1/1	